

# Table of Contents

<b>Lamp Construction</b>	3
Standard Metalarc	3
Super Metalarc	3
Metalarc Pro-Tech	4
Metalarc Safeline	4
Metalarc Brite-Line	4
Metalarc Pro-Tech PAR 38	4
<b>Theory of Operation</b>	4
External Igniters	5
Metalarc Brite-Line	5
Metalarc Safeline	5
<b>Operating Characteristics</b>	5
Operating Position	5
Lumen Output and Maintenance	7
Lamp Life	8
Effect of Temperature	8
Stroboscopic Effect	8
<b>Warnings</b>	8
Standard and Super Metalarc	9
Metalarc Pro-Tech	9
Metalarc Safeline	9
Metalarc Brite-Line	9
<b>Ballasting Metalarc Lamps</b>	9
Types of Enclosures	10
Types of Ballasts	10
Dimming Ballasts	12
Lamp Warm-Up Characteristics	13
<b>Spectral Characteristics</b>	13
Metalarc Coated	13
Metalarc 3K	13
Chromaticity Diagram	13
Spectral Power Distribution Curves	14
<b>Application</b>	13
<b>Troubleshooting</b>	15

The Sylvania Metalarc® lamp is a member of the high intensity discharge lamp family and is the most efficient source of white light available today. It has high efficacy, long life, exceptional color-rendering ability, and good lumen maintenance. Metalarc lamps are available in a broad range of sizes in wattages from 50 to 2000 and lumen packages from 3000 to 200,000. Most of the wattages are available in a coated version, which provides slightly better color rendition and slightly lower correlated color temperature. Some Metalarc lamps are available in a 3K version, which uses a special phosphor coating to achieve an incandescent-range correlated color temperature.

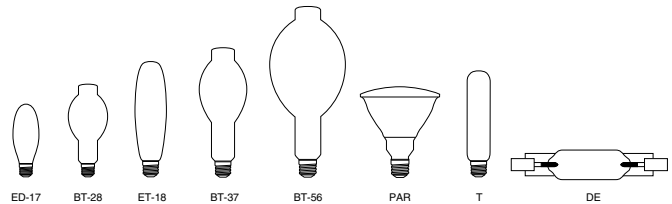

Figure 1. Metalarc Bulb Shapes. Bulb designation consists of a letter(s) to indicate shape and a figure(s) to indicate approximate maximum diameter in eighths of an inch.

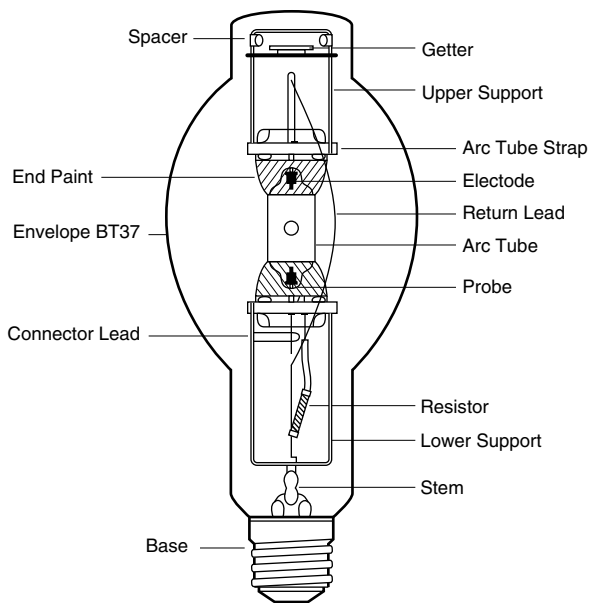

Figure 2. Construction of 400-watt Universal-Burning Metalarc Lamp.

## LAMP CONSTRUCTION

### Standard Metalarc Lamps

Lamps in the Metalarc family have a quartz arc tube which contains argon gas and mercury, plus a combination of two or more of the following: thorium, lithium, cesium iodide, iodide, sodium iodide and scandium iodide. These materials are responsible for the outstanding performance of this remarkable light source. The ends of the arc tube have a heat reflecting coating to control the temperature of these areas during operation. Temperature control is essential to the Metalarc lamp's operation (see page 8).

As shown in Figure 2, the Metalarc lamp uses a split frame construction. This is necessitated by the high

electrochemical activity of the additive system which requires maximum possible isolation of metal parts from the arc tube. The arc tube harness includes supports at the neck and/or dome, which make the mount structure very durable and resistant to rough service and vibration. The bimetal shorting switch closes during lamp operation, providing a short circuit between the starting electrode and the adjacent main electrode. This ensures that there is no potential difference between the main electrode and the starting electrode, which can lead to electrolytic failure of the arc tube seal. Some Metalarc lamps use a solid-state diode in addition to the bimetal switch. The diode augments the bimetal switch during lamp warm-up. A borosilicate (hard) glass bulb protects the inner parts and also absorbs ultraviolet from the arc.

## SUPER METALARC LAMPS

### Horizontal Type

Construction of the horizontal Super Metalarc lamp (Figure 3) differs from standard Metalarc lamps in several important respects. To control lamp operating position, a special Position Oriented Mogul Base (POMB) and Position Oriented Mogul Socket (POMS) have been developed. The POMB has a locating pin attached to the shell of the base that positively stops the lamp in the cutout of the POMS. The tolerances allowed for installation are +15% in two planes. The longitudinal axis of the lamp must meet this requirement and the vertical centerline of the body of the arc tube is held to the same limits. These tolerances are allowed in order to account for physical limitations of actual fixtures and installations. But the lamp is really a point design and the idea is to perfect orientation. If the allowed tolerances are exceeded, lamp performance will be compromised and life will be shortened.

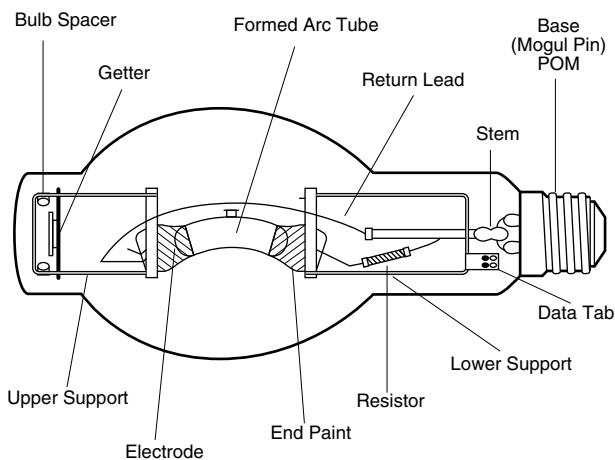

Figure 3. Construction of a horizontal Super Metalarc Lamp.

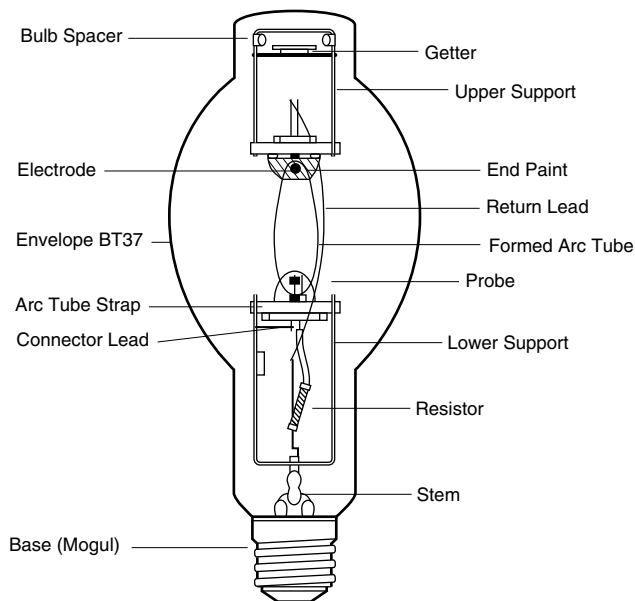

Figure 4. Construction of a vertical Super Metalarc Lamp.

The POMS will accommodate a standard mogul base, and mercury or Metalarc lamps can be used in these sockets.

**Vertical Type**

Since this lamp design (Figure 4) is intended for vertical operation, no special base-and-socket arrangement is required. With the exception of the special expanded-section arc tube, the vertical Super Metalarc lamp construction is identical to a standard Metalarc lamp.

**Metalarc Pro-Tech™ Lamps**

Metalarc Pro-Tech™ lamps (Figure 5) are designed to operate in open-fixture applications. A shield, which encompasses the arc tube, contains any quartz fragments that result from a non-passive failure of the arc tube. The shield has sufficient mass to decrease the momentum of the arc-tube fragments so that no quartz pieces go through the outer jacket. This eliminates the need for a lensed fixture.

**Metalarc Safeline® Lamps**

Metalarc Safeline® lamp's construction (Figure 6) is the same as the standard Metalarc lamps with the addition of a safety filament in series with the lamp dome end electrode. If the outer jacket is broken or punctured, the safety filament becomes exposed to oxygen in the air. Oxidation of the filament results in an open circuit within the lamp, causing it to self-extinguish within 15 minutes.

**Metalarc Brite-Line™ Lamps**

The Brite-Line™ family of Metalarc lamps (Figure 7) uses quartz as an outer jacket. Quartz is necessary because of the temperatures to which the jacket is exposed. The quartz is transparent to ultraviolet light and therefore the lamp must be operated in a suitably enclosed fixture. The fixtures are also required to have a power interlock on the lens cover which would automatically turn off lamp power if the lens is opened. For suitably enclosed fixture requirements, refer to: UL 1572.

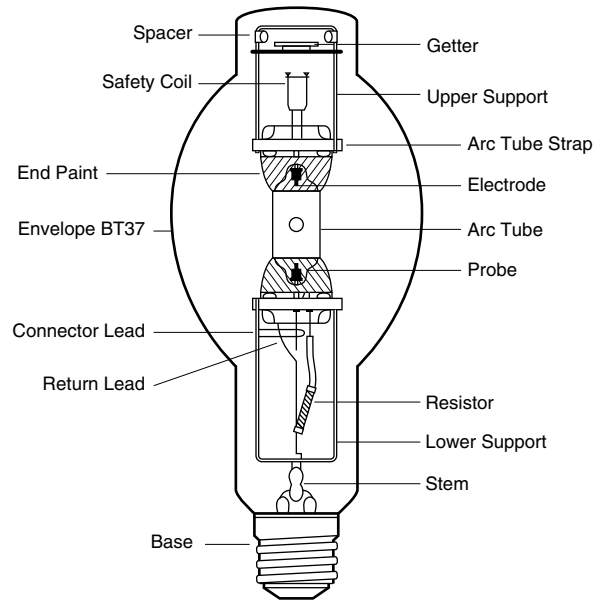

Figure 6. Construction of a Metalarc Safeline Lamp.

**Metalarc Pro-Tech PAR38 Lamps**

The Metalarc Pro-Tech PAR38 lamp uses a standard PAR38 outer jacket (Figure 8). The arc tube is mounted within a shield, as in other Metalarc Pro-Tech lamps, and is located at the focal point of the reflector to obtain maximum center beam candlepower. Lenses with different prescriptions are used to change the beam angle. The PAR38 Metalarc Lamp is available in three lenses: Spot, Flood, and Very Wide Flood. A typical candle power distribution can be seen in Figure 9. The candlepower distribution curves for the three prescriptions, in the available wattages, can be found in the OSRAM SYLVANIA Metalarc Specification Guide.

**THEORY OF OPERATION**

The iodide additives in the Metalarc system have boiling points considerably higher than the wall temperature of the arc tube and some of the material remains condensed in a solid state. In mercury lamps, by comparison, all of the discharge material is in a vapor state.

The quantities of the metallic iodides in the vapor state are governed by the temperature of the coldest spot on

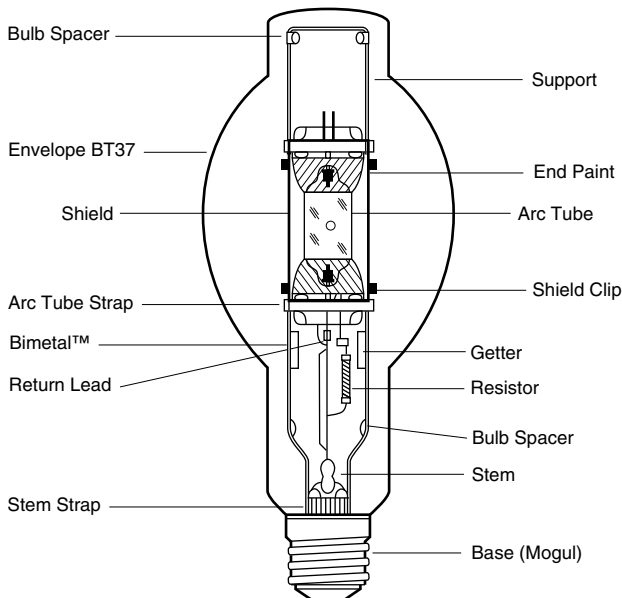

Figure 5. Construction of a Metalarc Pro-Tech Lamp.

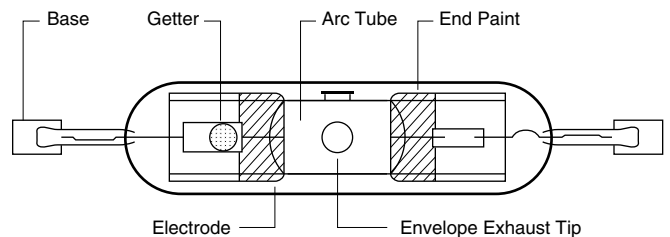

Figure 7. Construction of a Brite-Line Lamp.

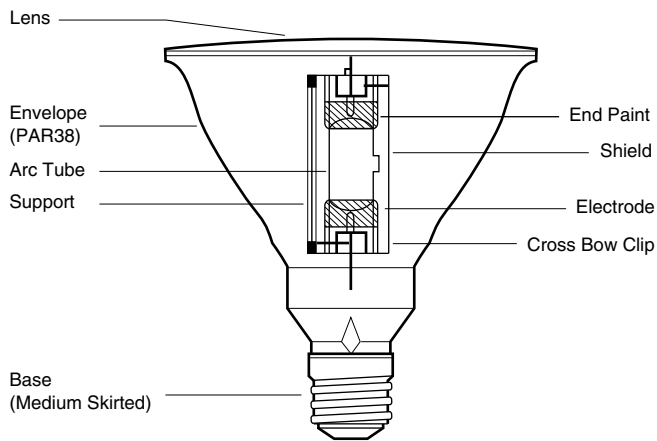

Figure 8. Construction of a PAR38 Metalarc Pro-Tech Lamp.

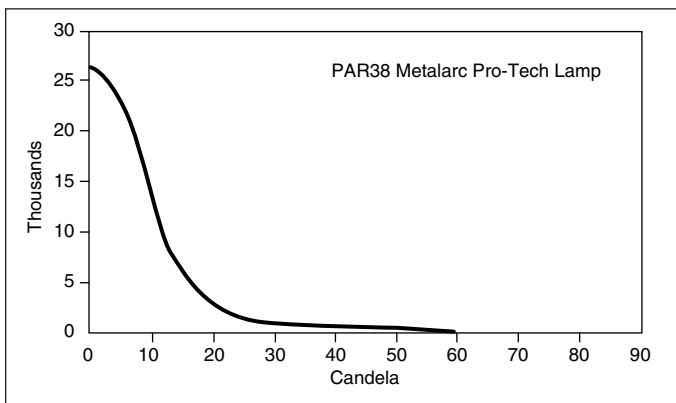

Figure 9. Typical Candlepower Distribution Curve (70W).

the interior surface of the Metalarc arc tube. This phenomenon accounts for many of the characteristics of Metalarc lamps.

The Metalarc lamp uses the same starting principle as a mercury vapor lamp, but differs significantly in starting requirements and characteristics. When voltage is applied to the lamp, initial ionization takes place in the space between the main electrodes and the adjacent starting electrode. Because of the presence of metal iodides in the arc tube, the voltage required for this to take place is much higher in a Metalarc lamp than in a mercury lamp. When there is sufficient ionization, the lamp will strike from the main electrode to main electrode.

Once the arc is established, the lamp begins to warm up. As the warm-up progresses, the metal additives begin to enter the arc stream and to emit their characteristic radiation. Because of the nature of the metal iodide additive system, the sustaining characteristics of the ballast are more stringent than those required for a mercury lamp.

When the lamp is fully warmed up and the additive metals are in proper concentration in the arc, the benefits of Metalarc lighting are clearly seen.

### External Ignitors

The newer, low-wattage Metalarc lamps, 150 watts and lower, require an external ignitor in the ballast circuit. The ignitor is needed to start the lamp by ionizing the gas within the arc tube and initiating the arc. Lamp types with starting probes do not require an external ignitor.

### Metalarc Brite-Line Lamps

Metalarc Brite-Line lamps operate in the same manner as the standard Metalarc lamp but require an external ignitor. Brite-Line lamps are jacketed in quartz and thereby require enclosed fixtures to eliminate UV hazards.

### Metalarc Safeline Lamps

Metalarc Safeline lamps operate in the same manner as the standard Metalarc lamp except when the outer jacket is broken by an external force, such as a basketball. The standard Metalarc lamp could continue to burn for many hours, but the Safeline lamp is designed to self-extinguish within fifteen minutes of breaking the outer jacket, thereby eliminating any UV hazard from the bare operating arc tube.

## OPERATING CHARACTERISTICS

### Operating Position

The published ratings of Metalarc lamps are established with the lamps operating in the vertical position, unless otherwise specified. While the majority of Metalarc products are universal-position lamps, when operated in positions other than vertical, the lamp wattage and lumen output decrease slightly as does the lumen maintenance and mean lumens over life. The operating positions which produce the lowest lumen output (and should therefore be avoided) are approximately 60-70° from the vertical position. In positions other than vertical, the arc tends to bend upward thereby producing non-uniform heating of the arc tube wall, resulting in less efficient operation—except for lamps designed for horizontal operation. Figure 10 is a graph of light output versus lamp operating position for Metalarc lamps. There is an operating position guide (Figure 13) on page 7 of this bulletin which details operating position ranges.

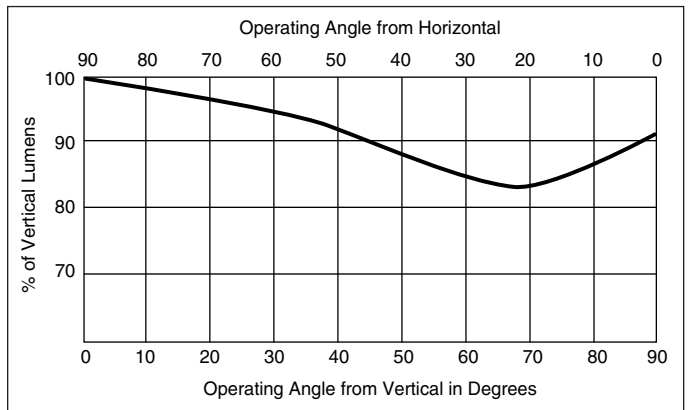

Figure 10. Metalarc Lamp light output versus lamp operating position.

Among the exceptions to the above is the 1500-watt standard lamp which is available only in a base-up-to-horizontal version and a base down version.

Super Metalarc and Metalarc Pro-Tech lamps have specific orientation requirements discussed below.

Each lamp type has operating position requirements as part of the lamp ordering information etched on the outer jacket of the lamp.

### **Horizontal Super Metalarc Type**

Super Metalarc lamps have specific orientation requirements based on detailed studies of the physics of the Metalarc discharge. The characteristics of particular interest are the effects of arc bending in non-vertical operating positions and the effect on cold spot temperature of various orientations. As a result of these studies, Super Metalarc lamps are designed for a single operating position and offer significantly higher efficacy.

By way of comparison, Figure 11 is a schematic of a standard Metalarc lamp operating in the horizontal position. The arc stream is bowed upward away from the axis of the arc tube, and additive material is condensed along the bottom surface. The bowing effect causes the top portion of the tube to approach the acceptable temperature limits of the quartz arc tube material. Conversely, the bottom of the arc tube is at considerably lower temperature and promotes condensation of the metal halide additives, thus affecting efficacy and color.

Horizontal Super Metalarc lamps are designed to adapt to and utilize these natural conditions. The arc tube is formed to accommodate the natural shape of the arc, thus providing uniform wall temperature (see Figure 3). This in turn increases both the amount and uniformity of additive material in the discharge with resultant higher efficacy and color uniformity. Super Metalarc lamps provide approximately 15 percent higher efficacy compared to straight-wall standard Metalarc lamps of similar wattage.

Horizontal Super Metalarc lamps have the same ballasting requirements as the same-wattage standard Metalarc lamps. All horizontal Super Metalarc lamps must be operated in suitably enclosed fixtures.

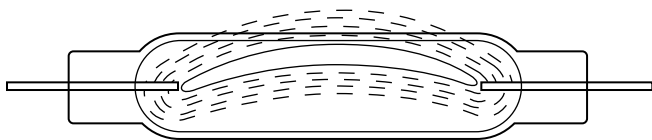

Figure 11. Schematic diagram of a standard Metalarc arc tube

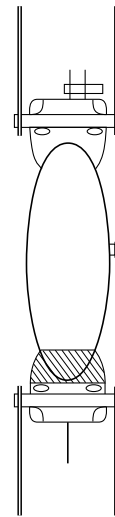

Figure 12. Arc tube geometry of the MS1000 Super Metalarc Lamp.

### **Vertical Super Metalarc Type**

Vertically operating Super Metalarc lamps are also the result of detailed studies of arc behavior. Many Metalarc lamps are operated vertically and any modification to improve efficiency in this orientation would be a significant benefit. As with the horizontal Super Metalarc lamps, adaptation of the lamp design to natural lamp operating conditions provides an improved Metalarc lamp.

In a vertically operated cylindrical arc tube, convection currents tend to separate into upper and lower patterns. The lower convection pattern is richer in the high-efficiency additive material, and its output is closer to that of a mercury discharge. The average effect of these two patterns is the total lamp output.

By forming the arc tube to the expanded section geometry shown in Figure 12, the convection circulation currents are modified to a single pattern with an overall increase in the additive content of the arc. This design increases lamp efficacy by 5 to 10 percent, depending on wattage.

The single convection pattern causes the arc to be slightly less stable than the arc in a straight-walled tube and there may be an almost imperceptible shifting or wandering effect.

Vertically operating Super Metalarc lamps have the same ballasting requirements as the same-wattage standard Metalarc lamps. Vertical Super Metalarc lamps are available in base up and base down designs and must be operated within 15° of vertical in suitably enclosed fixtures.

### **Metalarc Pro-Tech Lamps**

The operating characteristics of the Metalarc Pro-Tech lamp are similar to the standard Metalarc lamp of the same wattage and operating position. The Metalarc Pro-Tech family of lamps are designed to be operated in open fixtures and are constructed with a shield, which encompasses the arc tube, to contain any quartz fragments that result from a non-passive failure of the arc tube. The shield has sufficient mass to decrease the momentum of the arc tube fragments so that no quartz

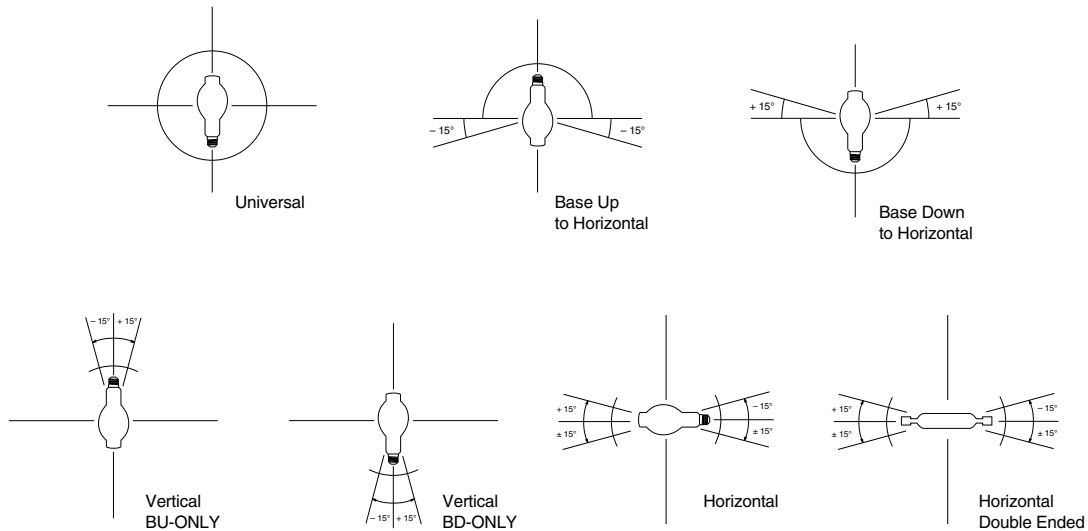

Figure 13. Operating position guide.

pieces go through the outer jacket.

### **Metalarc Brite-Line Lamps**

Brite-Line lamps are designed to operate horizontally. Lamps 150 watts and lower have quartz outer jackets to protect the seals and extend lamp life. Lamps 1000 watts and higher are fabricated without an outer jacket; still, the arc tube is made of quartz. Quartz is required because of the high operating temperatures. Quartz is transparent to UV light. In addition, arc tubes have the risk of non-passive failure; thus, all Brite-Line lamps must be operated in suitably enclosed fixtures. The fixtures must have interlocks on the lens cover to prevent any UV exposure. For suitable enclosed fixture requirements, refer to UL 1572.

### **Compact Metalarc Lamps**

These lamps operate in the same way as standard Metalarc lamps of equivalent wattage with the exception of higher outer jacket and base temperatures. Operating parameters of the various lamps in the previous sections must be adhered to. This family of lamps has reduced light center lengths and reduced maximum overall lengths as compared to Metalarc lamps of the same wattage and operating position.

### **Lumen Output and Maintenance**

The Metalarc system is chemically complex and requires 100 hours of operation for all its components to stabilize and for the lamp to reach a set of performance characteristics that are a meaningful basis for specification of performance over life. For this reason, when evaluating a Metalarc lighting installation, the lamps should be operated for the 100-hour period to allow them to stabilize. All published lamp specifications are based on 100-hour measurements.

Metalarc lamps have superior lumen maintenance characteristics. The decline in light output over lamp life is very gradual. The three major causes of the decline in output are deterioration of the electrodes over time, loss of transmission of the arc tube due to blackening, and

shifts in the chemical balance of the additive materials. The lumen maintenance is better when Metalarc lamps are burned for a longer period per start; hence, the best maintenance will result from continuous operation.

**NOTE: When Metalarc lamps are used in a continuously operating mode, OSRAM SYLVANIA recommends that a timer be included in the lighting circuit to cycle the lamps off for a minimum of fifteen minutes at least once per week.**

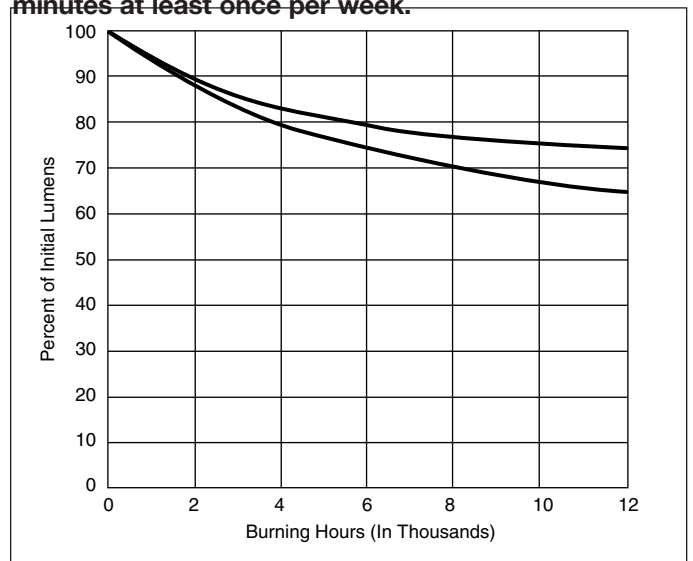

Figure 14. Typical lumen maintenance curve.

The lumen maintenance varies somewhat with lamp size. In the case of a phosphor-coated lamp, there may be an additional depreciation of light with life due to the depreciation of the phosphor inside the lamp. Horizontal lamp lumen maintenance is approximately five percent lower than vertical lamp maintenance at the end of rated life. Figure 14 shows a typical Lumen Maintenance Curve. For specific Lamp type curves, refer to the OSRAM SYLVANIA Metalarc Specification Guide.

## Lamp Life

Metalarc lamp life is the elapsed time in hours at which 50 percent of a large sample population will have reached normal end of life when operated at controlled nominal ballast input, on 10-hour cycles in the vertical base-up position. (Super Metalarcs in horizontal or vertical nominal design position.)

Normal end of life is failure to start or come up to design power. This is caused by gradual deterioration of the lamp's electrodes over life. Electrode deterioration is most severe during starting. Longer operating cycles yield longer lamp life and better lumen maintenance.

The shape of the Metalarc mortality curve differs from incandescent and fluorescent lamps in that it does not contain a sudden sharp dip. A typical mortality curve can be seen in Figure 15. For specific lamp type curves refer to the OSRAM SYLVANIA Metalarc Specification Guide.

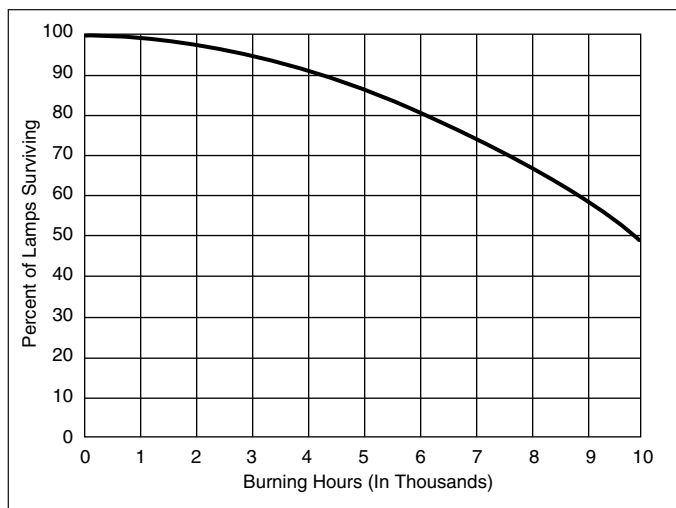

Figure 15. Typical lamp mortality curve.

## Effect of Temperature

Operation of the Metalarc lamp is essentially independent of ambient temperature because the outer jacket controls the arc tube's operating ambient temperature. Wattage, lumen output, and color do not vary appreciably with ambient temperature. However, ambient temperature can affect ballast performance which in turn can affect lamp operation.

While the arc tube is protected and relatively independent of ambient lamp environmental temperature, certain environmental conditions must be maintained for normal lamp performance. Among these are 210°C maximum on the mogul screw base, and 350°C on the outer glass bulb of all low wattages, Metalarc Pro-Tech PAR38 types and all 175- and 250-watt types; 400°C on all other types. Refocusing or concentration of energy, or use of auxiliary equipment such that internal lamp components are subjected to abnormal thermal, mechanical or electrical conditions, must be avoided. (Abnormal being significantly different from those normally associated with operation in typical contemporary general lighting luminaires with 60-hertz magnetic metal halide auxiliary equipment.) The complexity of lamp, luminaire and auxiliary equipment interrelationships necessitates much

care in the design of new products or modification of existing ones.

The starting of Metalarc lamps is especially sensitive to temperature. At low temperatures, the reduced mercury vapor pressure makes lamp ignition more difficult. In a hot restrike condition, following a power interruption, the lamp must cool so that the arc tube pressure is reduced before the ballast voltage is sufficient to start the lamp. The minimum starting voltages required to assure starting reliability at 50°F and -20°F are listed in Table 1 on page 10.

## NOTE TO LIGHTING EQUIPMENT DESIGNERS:

In equipment design, extreme caution must be used to assure that the thermal environment created by the system and the electrical input comply with the nominal conditions discussed above. Deviation from these nominal conditions may cause a change in lamp operating voltage, wattage, and lumen output and result in deterioration of lamp components, resulting in reduced lamp performance.

## Stroboscopic Effect

The arc in a Metalarc lamp, and all other electric discharge lamps operated on a 60-hertz alternating current, is completely extinguished 120 times per second. The light output of the lamp is modulated at this rate. This variation is greater in a clear lamp than in a Metalarc Coated or a 3K Metalarc lamp (described on page 13). With the phosphor-coated lamps, there is some phosphorescence or "carry-over" action. That is, the coating continues to glow for a short period of time after the radiation from the arc is cut off. However, there is still a rapid variation in light output which, under certain circumstances, may produce what is called a stroboscopic effect. Because of the stroboscopic effect, an object that is moving at a uniform speed may appear to move in jerks. Under the most extreme conditions, a rotating object, such as a flywheel, may seem to be standing still or even rotating in a reverse direction. Stroboscopic effect is often unnoticed and in most installations it is not a problem. It may be reduced by operating pairs of lamps on lead-lag type ballasts or groups of three lamps on separate phases of a three-phase circuit. Many installations of Metalarc lamps are performing satisfactorily in areas where very fast motion occurs, such as machine shops, gymnasiums, tennis courts and other sports areas.

The physical, electrical, and photometric characteristics of Metalarc lamps are given in the OSRAM SYLVANIA Metalarc Specification Guide.

## WARNINGS

High Intensity Discharge lamps can cause serious skin burn and eye inflammation from shortwave ultraviolet radiation if the outer envelope (glass bulb) of the lamp is broken or punctured. Do not use where people will remain for more than a few minutes unless adequate shielding or other safety precautions are used. Lamps that will automatically extinguish when the outer envelope is broken or punctured are commercially available from OSRAM SYLVANIA Inc.

### **Standard and Super Metalarc Lamps**

Metal Halide arc tubes operate under high pressure (up to 50 p.s.i.) and at very high temperatures and can unexpectedly rupture due to internal causes or external factors such as a ballast failure or misapplication. An arc tube rupture can burst and shatter the outer glass bulb resulting in the discharge of glass fragments and extremely hot quartz particles (as high as 1832°F–1000°C). In the event of such rupture, there is risk of personal injury, property damage, burns and fire.

All Standard and Super Metalarc lamps (except 400- and 1000-watt operating with 15° of vertical) must be operated in enclosed fixtures which comply with UL Standard 1572 (revised December 26, 1988). Such fixtures should withstand an arc tube rupture. Refer to the fixture manufacturer data for compliance with UL 1572.

### **Metalarc Pro-Tech Lamps**

All Metalarc Pro-Tech lamps are designed for use in open fixtures. They contain a special shield designed to contain a ruptured arc tube, thereby minimizing the resultant risk of personal injury, property damage, burns and fire. In addition, they must be operated in the designated burning position as shown on the outer glass bulb, i.e., BU (Base Up). In applications requiring an additional measure of safety, an enclosure material that complies with UL Standard 1572 can be used.

### **Metalarc Safeline Lamps**

All Metalarc Safeline lamps are designed for use in open fixtures and must be operated in the designated burning position as shown on the outer glass bulb, i.e., BU (Base Up).

This lamp should self-extinguish within 15 minutes after the outer envelope is broken or punctured. If such damage occurs, turn off and remove lamp to avoid possible injury from hazardous shortwave ultraviolet radiation.

### **Metalarc Brite-Line Lamps**

These lamps must be operated only in a suitably enclosed fixture to reduce the risk of personal injury and property damage resulting from an arc tube rupture. A suitably enclosed fixture uses lens/diffuser material able to contain fragments of hot quartz (up to 1832°F). Enclosed fixtures which comply with UL Standard 1572 should withstand an arc tube rupture.

Exposure to shortwave ultraviolet radiation from this lamp can cause serious skin burn and eye inflammation. Use only in equipment provided with a lens cover of high temperature aluminosilicate glass (such as Corning Corlite®) or equivalent which filters out harmful shortwave ultraviolet radiation.

The fixture must have a power interlock device to automatically turn off the lamp if the fixture assembly is opened. If the fixture lens is broken, turn off power immediately. People should not remain in the area for more than a few minutes without adequate shielding or other safety precautions while lamp is operating with a broken lens.

## **BALLASTING METALARC LAMPS**

The Metalarc lamp achieves its high efficacy and excellent color characteristics from the additives in the discharge. The presence of metal iodides in the lamp lead to special ballasting requirements. The iodides make it more difficult to ionize the gas in the arc tube therefore a higher open circuit voltage is required to start a Metalarc lamp.

Metalarc lamps present a negative resistance characteristic to the supply circuit, therefore a ballast is required to supply the proper starting voltage and current conditions to operate and sustain the lamp at the proper wattage over its lifetime. For a given range in supply voltage a ballast must maintain the proper operating current to the lamp. Any AC arc discharge lamp extinguishes every electrical half-cycle or one hundred and twenty times a second on the sixty hertz supply. The lamp requires sufficient voltage to reignite every half-cycle. This voltage required is higher with Metalarc lamps than with mercury vapor lamps due to the presence of the metal iodides. This reignition voltage is affected by the current waveform of the current supplied to the lamp especially during the time just before a zero-crossover. A current off-time period prior to the zero-crossover reduces the arc conductivity and leads to a higher voltage requirement to reignite the lamp on the next half-cycle.

A ballast must operate a lamp within ANSI prescribed wattage and voltage limits. Wattage limits for all Metalarc lamps are generally +/-20 percent of nominal wattage. A ballast must operate a nominal voltage Metalarc lamp within +/-5 percent of rated wattage with rated line voltage applied to the ballast. Specific requirements are found in the appropriate ANSI C78 lamp or C82 ballast specifications.

To provide good lumen maintenance and rated life, a lamp current crest factor of 1.8 or less is required. Current crest factor is the ratio of peak to r.m.s. current.

Several types of ballasts are available, each having performance and cost advantages or disadvantages. Reactor ballasts with sine-wave waveforms are satisfactory for Metalarc lamp operation if the peak open circuit voltage requirements are met. Starting voltage requirements for Metalarc lamps are given in Table 1. Similar wattage standard and Super Metalarc lamps operate on the same auxiliary equipment. Mercury vapor lamps may be satisfactorily operated on metal halide ballasts of the same wattage but not vice versa.

Ballasts are described as normal power factor or high power factor. Normal power factor ballasts have power factors less than 90 percent, such as simple reactors. High power factor ballasts have power factors greater than 90 percent. Lag ballast power factor may be increased to greater than 90 percent by incorporating an input capacitor across the input supply line. Operating at the high power factor means the circuit is operating near the minimum line current. Uncorrected lag circuits operating at 50 percent power factor draw significantly more current for the same wattage.

Lamp Watts	Sine-Wave Ballast 1.414 Crest Factor				Typical Lead-Peaked Ballast 1.82 Crest Factor*	
	Peak Volts		RMS Volts		RMS Volts	
	Above 50°F	Below 50°F to -20°F	Above 50°F	Below 50°F to -20°F	Above 50°F	Below 50°F to -20°F
175	495	540	350	382	270	300
250	495	540	350	382	270	300
400	495	540	350	382	280	295
1000	622	750	440	530	360	400
1500	622	750	440	530	370	410

Table 1. Minimum ballast voltage requirements for Metalarc lamps.

Note: These are minimum requirements for 98 percent probability of starting at 50°F and 90 percent probability at -20°F.

**IMPORTANT:** Metal Halide (lead-peak) ballasts will operate mercury lamps of equal wattage. Mercury (sine-wave) ballasts will operate Metalarc lamps only if the above required peak voltage is available from the ballast at the specified temperatures.

\*Refer to ANSI Standards for crest factors and voltages other than those listed.

There is increased usage of single-ended and double-ended low wattage Metalarc lamps on simple reactor circuits. These ballasts generally require external ignitors for lamp starting. A portion of the ballast winding is frequently used to provide an L di/dt voltage pulse sufficient to start the lamp. In some instances, multiple pulses during the half-cycle may be required. Consult the ANSI lamp specifications or the lamp manufacturer for the pulse requirements.

The ballast must provide sufficient current during start-up to allow a lamp to reach full stabilization in an appropriate amount of time. If the starting current is too low, the lamp may not reach rated light levels and could result in longer than expected life. High starting current will give faster run-up times, but generally short lamp life. The minimum and maximum allowable starting currents for Metalarc lamps are given in the C78.13xx series of American National Lamp Standards, or can be obtained from the lamp manufacturer.

### Types of Enclosures

The core and coil is the most common type of ballast. It is comprised only of the copper coils mounted on the steel laminations with any associated capacitors and ignitors, and may be used by itself as a component of a fixture or luminaire. Class H insulation is most commonly used in core and coil ballasts, which permits a hot spot temperature of 180°C.

The potted core and coil is used in applications where the noise is to be minimized, such as schools and stores. Core and coil ballasts are encased in high temperature resin and mounted in the fixture with conventional mounting hardware.

F-can ballasts are designed for indoor, low noise applications and utilize the familiar florescent type ballasts cans, and are located near the lamp.

Indoor enclosed units are used in applications where the ballast is located remote from the fixture, such as in high bay lighting found in factories. The remote location allows the ballasts to be operated in a cooler ambient environment than the fixture operates. A core and coil ballast is mounted and encased in a heat dissipating

resin in a metal enclosure. Standard indoor ballasts are designed to operate in ambient air temperatures of up to 40°C (105°F).

Outdoor weatherproof ballasts are designed for remote pole-top mounting. The units are typically placed on a heat sink base and enclosed in an aluminum cover bolted to the bases. Generally, no fill compound is used.

Post Line ballasts are mounted in slender cylindrical shaped enclosures which fit in poles. Specially designed slender core and coil ballasts are encased and potted in a high temperature resin.

### Types of Ballasts

Ballasts fall into two broad categories: lag and lead circuits. The lag (or lead) refers to the phasing of the lamp current relative to the input voltage. Simple reactor and leakage reactance ballasts are lag circuits. The constant wattage autotransformer (CWA) ballast for Metalarc lamps is a lead circuit and produces a high open circuit peak voltage with a crest factor of about 2.0.

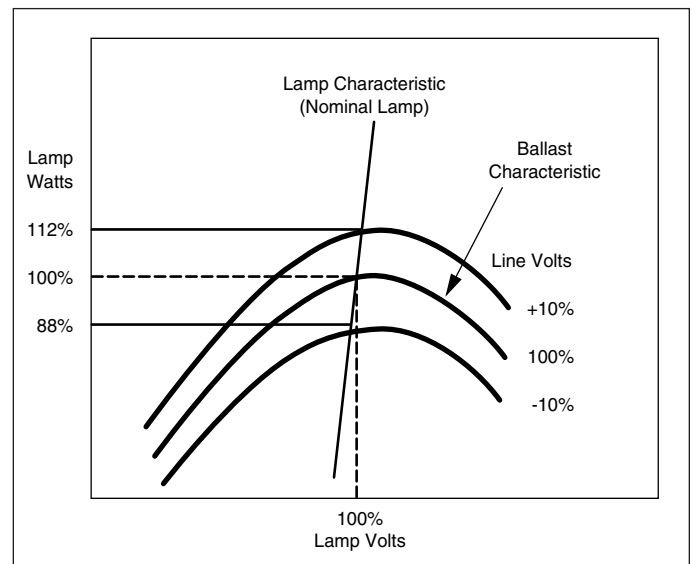

Figure 16. Typical output regulation reactor ballast (LAG).

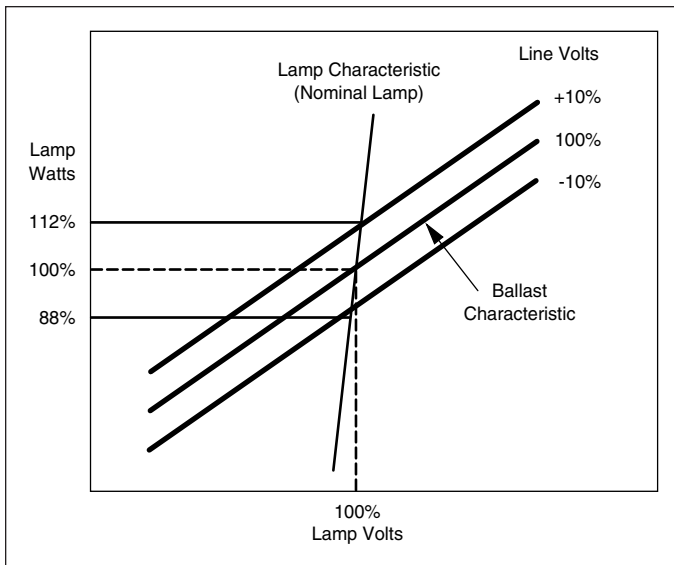

Figure 17. Typical output regulation autotransformer (CWA) ballast.

There are two types of regulation to consider in evaluating Metalarc ballasts and these are illustrated in the plots of lamp watts versus lamp volts, which can be seen in Figures 16 and 17. The first regulation describes the output variation due to input line voltage variation. The second regulation characterizes the output variation as a function of lamp voltage. The shape of the ballast characteristic curve is different for lead and lag circuits.

The plots are comprised of two important characteristic curves, the ballast characteristic and the lamp characteristic. The ballast characteristic curve describes the locus of operating points, at constant input voltage, for lamps of any voltage. The operating points of all lamps will lie on this curve. The lamp characteristic is a nearly vertical line and only applies to a single lamp. A lamp will operate on its lamp characteristic curve depending on its current. The lamp current can be varied by changing the input voltage to the ballast or its impedance. The stable operating point is at the intersection of the ballast characteristic curve and the lamp characteristic curve.

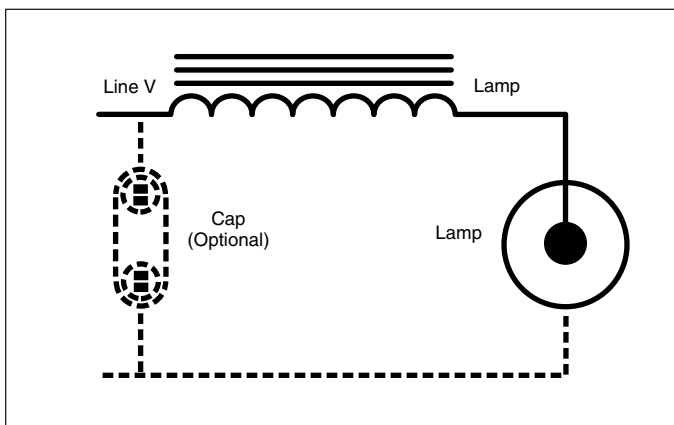

Figure 18. Typical reactor circuit with optional capacitor.

### Simple Reactor

The AC air-gap reactor, or choke, is the simplest form of a useful ballast. It is comprised of a winding on a magnetic core, usually gapped to provide the appropriate reactance. A typical reactor circuit can be seen in Figure 18. A reactor is a lag-type ballast used for operating Metalarc lamps only in conjunction with an external ignitor at input voltages below 277 volts. Operation without an external starting aid is possible at 480 volts input. It is the least expensive ballast and has the disadvantages of poor output regulation with input line variation and low power factor. The ballast characteristic curve typically bends over near rated lamp voltage. The location of the maximum wattage is dependent on the input voltage rating. High voltage lamps generally operate on the downward-side of the ballast characteristic curve as illustrated in Figure 16.

The input line voltage must be held to about +/-5 percent voltage to maintain +/-12 percent output regulation. This may be acceptable for some applications. If the input line voltage is fairly constant, then the output regulation is good for a range of lamp voltages since the operating points lie on a relatively flat portion of the ballast characteristic curve.

The 50 percent power factor of a reactor ballast may be improved to greater than 90 percent with an appropriately sized capacitor placed across the input to the ballast. This significantly reduces the current drawn by the ballast and the input wiring size. The capacitor across the input has no effect on lamp operation.

Lamps warm-up faster on a reactor circuit because the current at start-up is relatively high, or about 1.5 times the stabilized current. This may have to be taken into consideration in wiring design.

Lamp current crest factor is generally less than 1.5, well below the 1.8 maximum limit required by ANSI, or the lamp manufacturer, for satisfactory lumen maintenance and rated life.

### Leakage Reactance Ballast (or High Reactance Autotransformer, HX)

A leakage reactance autotransformer is a lag-type ballast typically used in circuits where the line voltage is insufficient to start the lamp. An artificial leakage flux path, between the primary and secondary windings, produces a voltage in the windings equivalent to an inductive-reactance voltage drop in series with the lamp. The ballast provides two functions in one magnetic circuit. First, the output voltage is either stepped-up or down from the line supply voltage to provide the proper open circuit starting voltage, and secondly, to provide a reactance to limit the lamp current. The autotransformer section has a portion of the primary and secondary circuit in common resulting in a lower cost. Like the reactor ballast, the autotransformer is a normal power factor ballast (50 percent) which can be raised to greater than 90 percent by addition of a capacitor across the input supply line. The operating characteristics are similar to the simple reactor circuit. Figure 19 shows a typical high reactance autotransformer circuit.

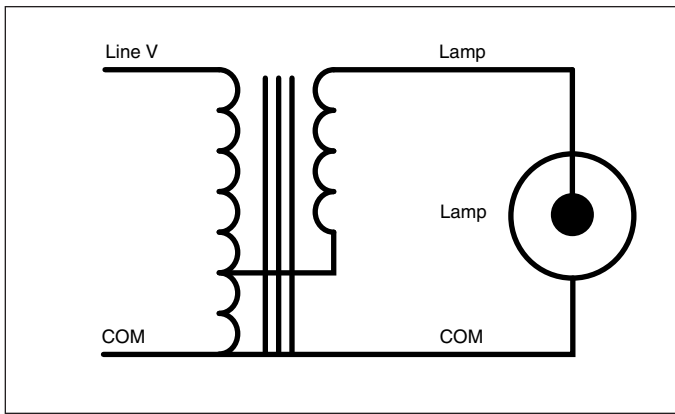

Figure 19. Typical high reactance autotransformer circuit without capacitor.

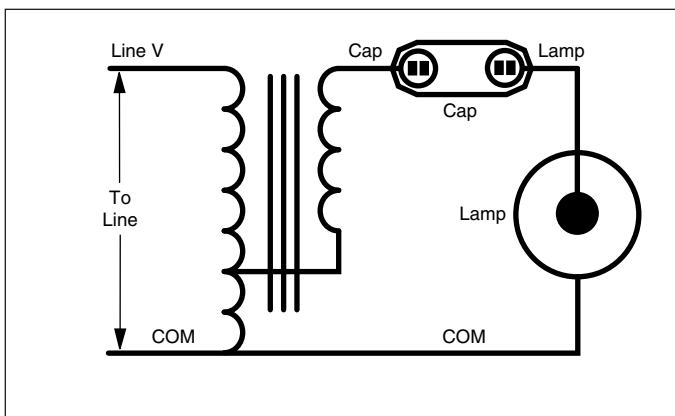

Figure 20. Typical constant wattage autotransformer circuit.

### **Constant Wattage Autotransformer (CWA, lead-peaked)**

This is the most commonly encountered ballast for lamp wattages greater than 150 watts, because it is the best compromise between cost and performance. The capacitor in series with the lamp, as seen in Figure 20, makes it a high power factor ballast. The series impedance is comprised of about twice as much capacitive reactance as inductive reactance, making it a lead circuit. Portions of the primary and secondary winding are in common and provide greater or lesser voltage, as required, than line voltage at the output. The output voltage waveform is peaked by the insertion of one or more core slots in the secondary circuit resulting in a high peak voltage for lamp starting superimposed on a relatively low r.m.s. voltage sine-wave. This feature contributes to the cost advantage for the CWA ballast.

The regulation of a CWA ballast is different from the reactor circuit. The ballast characteristic curves are more closely spaced for input supply voltage variations so that a ten percent line voltage variation results in only five percent lamp wattage variation. The ballast characteristic curves increase linearly through the range of normally encountered lamp voltages, and lamps at the high

voltage end of the manufacturing tolerance operate at higher wattage than for the lower voltage lamps. The inherent wattage limitation of reactor circuits with higher voltage lamps is not found in the CWA circuit.

Lamp current during starting is not much greater than for stabilized operation, hence lamp warm-up will be slower than on a reactor circuit.

A CWA ballast can tolerate line dips of 40 to 50 percent without dropping-out vs. about 25 percent for reactor circuits.

The current crest factor during any time of operation for Metalarc CWA circuits is typically 1.60 to 1.8, closer to the maximum 1.8 limit than reactor circuits.

Lamps operated on CWA ballasts have a non-sinusoidal current waveform with a higher crest factor than a reactor ballast and with a low-current off-time region during the last 2.75 milliseconds of the AC half-cycle. Limits are placed on the allowable current off-time, overshoot and crest factor.

A voltage referred to as Sustaining Voltage ( $V_{ss}$ ) must be provided by a lead-peak ballast immediately following starting to sustain a lamp during its run-up to full power. Metalarc lamps may develop reignition spike voltages during warm-up which the ballast must sustain. The magnitude of the spike reignition voltage is an inter-relationship between the current slope ( $di/dt$ ) during its zero-crossover and the current off-time (O.T.).  $V_{ss}$  is the difference between the instantaneous voltage across the series capacitor and the open circuit voltage as described in ANSI/ASC C82.6. Tables of lamp sustaining voltage requirements are given in the appropriate C78.13xx ANSI lamp standards. Reactor ballasts do not have sustaining voltage requirements since they provide full sine-wave voltage to the lamp without a current offtime.

The lamp current during the current O.T. is limited to a small amount of current overshoot (O.S.), generally less than 100 milliamperes. Current O.S. is a brief excursion of current below the zero axis, and excessive current O.S. results in unstable lamp operation and lamp dropout. The magnitude of the current O.S. is increased with stiffer supply lines or lower source impedances.

### **Dimming Ballasts**

Dimming ballast systems are now available for Metalarc operation. The increased interest in dimming ballasts is a response to regulatory requirements for more efficient use of energy and the programmability of light levels.

Some ballast manufacturers are presently selling Hi/Lo systems which operate lamps at normal wattage during periods of activity, and at about 50 percent wattage during inactive periods. Engineering tests indicate lamps operating on these systems meet ratings at normal wattage but have low lumens and poor color at reduced wattage. Lamps must be started and operated at nominal wattage for at least fifteen minutes prior to reducing the power. Starting at reduced power is harmful to the lamp. Electrode temperatures and electron emission are lower at reduced lamp current.

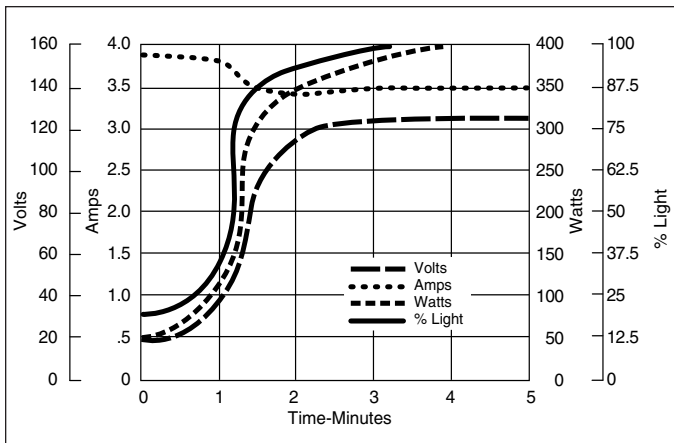

Figure 21. Warm-up characteristics of a 400-watt Metalarc Lamp.

### Lamp Warm-up Characteristics

Figure 21 shows the lamp warm-up characteristics of a 400-watt Metalarc lamp on a typical commercial lead peak autotransformer ballast. The characteristics of other Metalarc lamps are similar.

### SPECTRAL CHARACTERISTICS

The spectral output of Metalarc lamps contains all of the wavelengths that the human eye is responsive to, and much of the radiated energy is shifted into areas of the spectrum where the mercury lamp is deficient. Since all wavelengths or colors are included in good relative balance, the overall appearance of the lamp color is white, thus providing excellent rendition of all colors.

The spectral power distributions of Metalarc lamps are shown in Figures 23 to 30 on page 14. Note the continuous spectrum throughout the visible band.

### Metalarc Coated Lamps

Although the Metalarc lamp has excellent color quality for most lighting applications, there are some interior lighting applications, such as retail stores, supermarkets, and other commercial interiors, where even better color rendition is desirable. For these applications, the Metalarc coated lamp is recommended. This lamp has a phosphor coating which increases the percentages of red, orange and yellow wavelengths in the spectrum, as depicted in the curves. The Metalarc/C lamp also features a lower color temperature (warmer light) and a more diffuse source of light which aids in reducing brightness and glare.

### Metalarc 3K Lamps

For lighting applications where an even warmer light source is desired, the 3K Metalarc lamp is available which has a color temperature in the same range as incandescent sources.

### Chromaticity Diagram

Figure 22 is a graphical representation of the apparent color of a lamp. This graph is called a chromaticity (color) diagram and shows the x and y coordinates, or

the design center of a Metalarc lamp. It also shows the correlated color temperature in degrees Kelvin. The letter "C" in the diagram is the design center of a 1000-watt clear Metalarc lamp. The chromaticity coordinates have manufacturing tolerances just as are found in lumens and physical size tolerances. On a chromaticity diagram, the limits, or tolerances, for a particular lamp are described by a "color oval" as shown in Figure 22.

A completed lamp must have its x and y chromaticity coordinates fall within this oval in order to meet the manufacturing specifications for an acceptable lamp. During the first 100 hours of operation of a lamp, the oval does not apply since the lamp has not fully stabilized and settled into its final color. Lamps aged 100 hours within their designated operating position, however, should fall within the color oval when operated at design wattage. No color evaluation should be made, therefore, on a newly installed group of lamps which have not operated 100 hours. It must be understood that the apparent color of the lamp does not indicate that the lamp is not producing the full rated lumen output, nor does it indicate that its color rendering ability is inadequate. Color samples illuminated by the lamp will verify the adequacy of the color, and a footcandle meter will demonstrate the relative lumen output of the lamp.

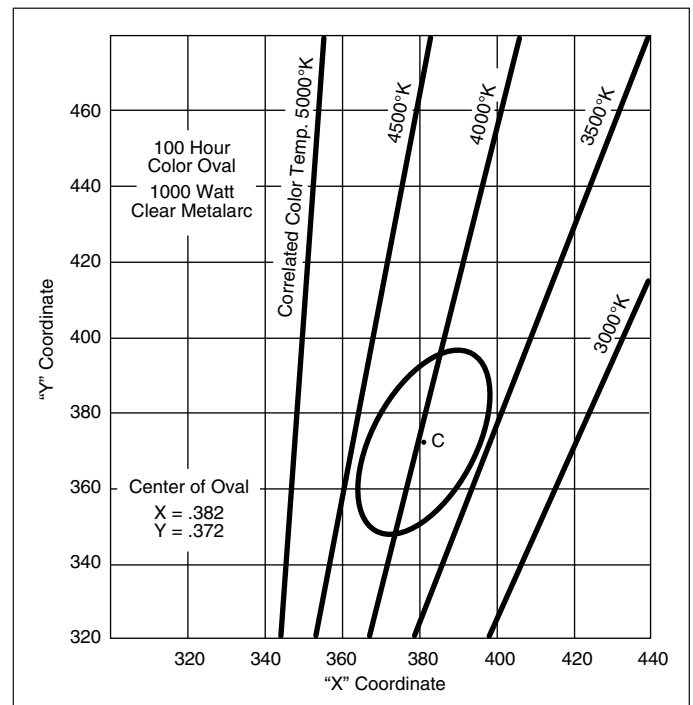

Figure 22. Typical Chromaticity Diagram.

## METALARC APPLICATIONS

### Industrial Lighting

Metalarc lamps, especially the 400-watt and 1000-watt sizes, are the best choice for most industrial lighting applications that require relatively high mounting of the luminaries. Obviously, the entire range of lamps can be applied to the various mounting heights with intensity

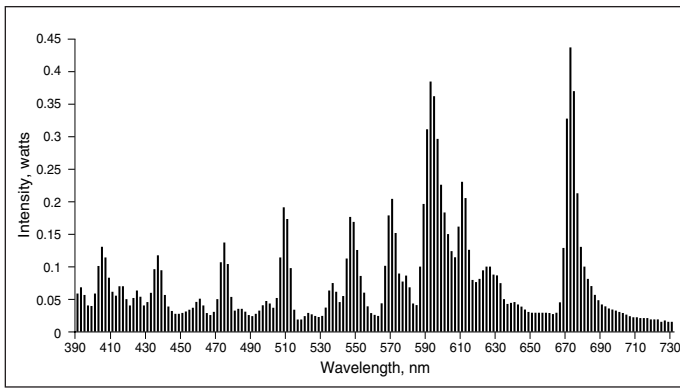

Figure 23. Metalarc clear 100-watt lamp.

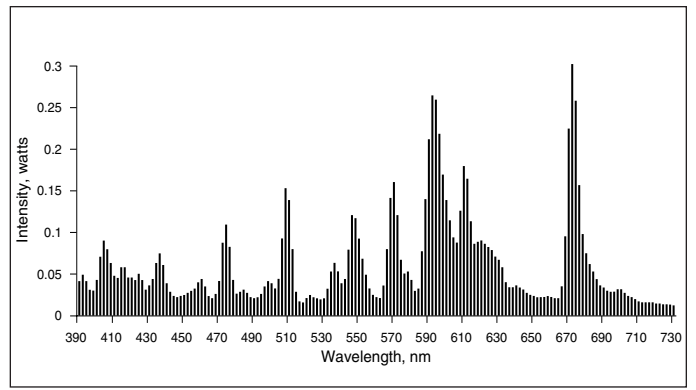

Figure 24. Metalarc diffuse coat 100-watt lamp.

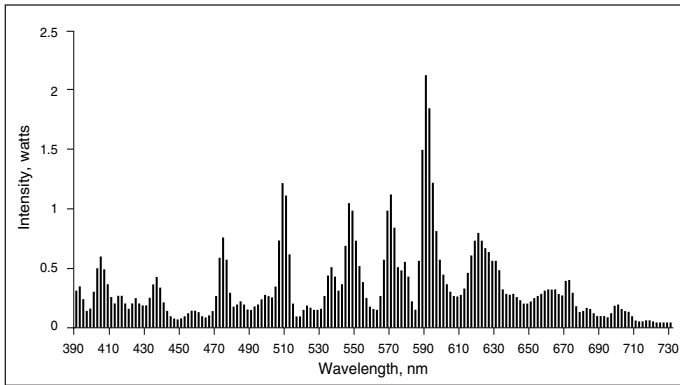

Figure 25. Metalarc coated 3K 400-watt lamp.

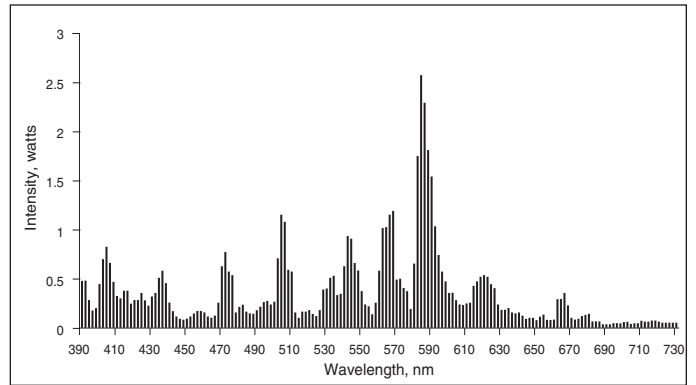

Figure 26. Metalarc MP clear 400-watt lamp.

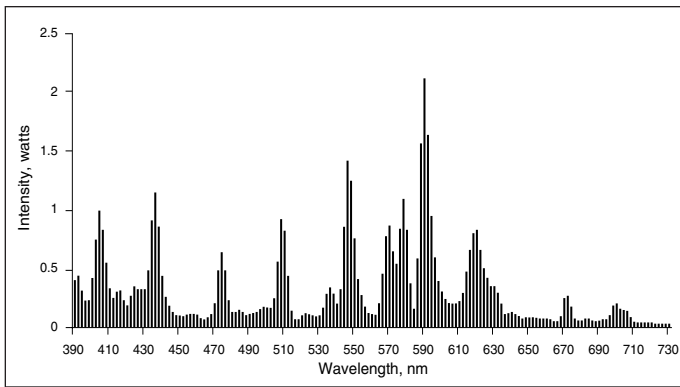

Figure 27. Metalarc coated 400-watt lamp.

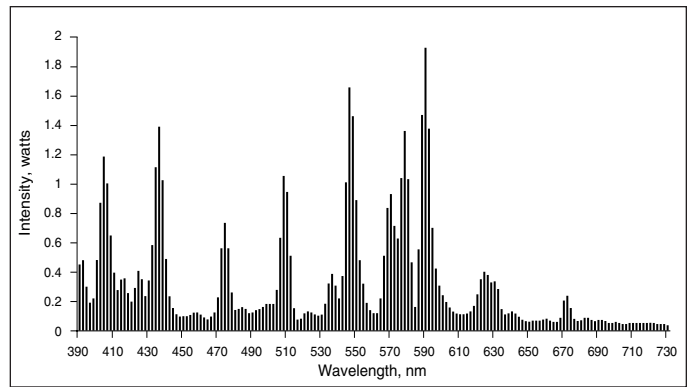

Figure 28. Metalarc clear 400-watt lamp.

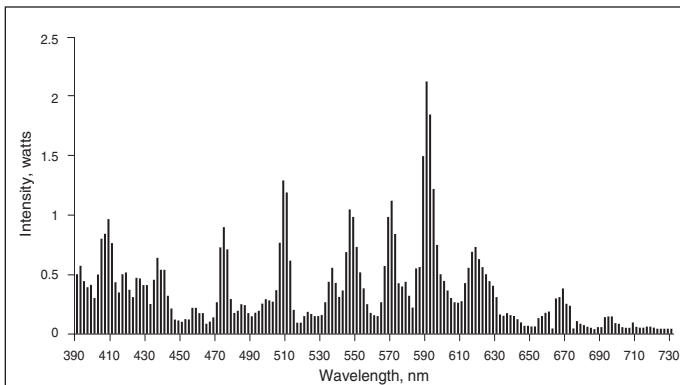

Figure 29. Super Metalarc coated 400-watt lamp.

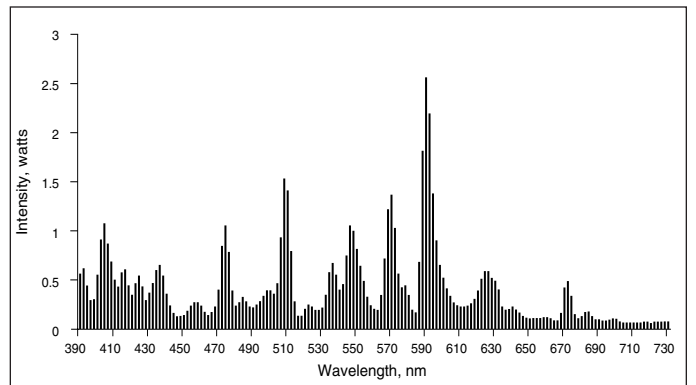

Figure 30. Super Metalarc clear 400-watt lamp.

requirements met for interior lighting. In one installation, over nine hundred 400-watt Metalarc lamps, mounted at 20 feet, provide lighting of 80 footcandles in the unclean atmosphere of a metal stamping and forming plant. At Cape Kennedy's Jet Propulsion Laboratories Spacecraft Assembly area, 1000-watt Metalarc lamps are mounted 60 feet above the floor in a 180 x 50-foot room. A lighting level of 500 footcandles of shadowless white light, with faithful color rendition, permits rapid documentary and engineering sequential color photography without the use of filters or other corrective means. In chemical and petroleum plants, where color identification of pipes, circuits, warning or caution areas is of paramount importance, Metalarc lamps have found ready acceptance.

For outdoor areas adjacent to factories, the high efficacy of Metalarc lamps permits economical parking lot lighting and similar installations. Another interesting outdoor application is the illumination of one of the nation's floating dry docks with Metalarc lamps. The wealth of bright, white light allows after-dark repair and finishing activities with a minimum of supplemental lighting.

### **Used Car and Parking Lots**

The true color rendition properties of Metalarc lamps have made it easy to locate a car by its color in the general lighting of extensive sales lots. There are now many installations using poles 30- to 120-feet high with two or more 1000-watt Metalarc lamps per pole to produce bright, uniform illumination. The sales of used cars depend on the glitter, sparkle, and true color rendition of cars. Many used car lots across the country are currently enjoying increased sales, with the brighter, more efficient lighting of Metalarc lamps to add appeal to cars.

### **Building and Sign Flood Lighting**

In the realm of advertising, sign boards and building floodlighting, the 400-watt Metalarc lamp is being given prime consideration as the workhorse of the industry. Billboards lighted from the bottom with several Metalarc lamps in floodlighting equipment assume dramatic new dimensions with excellent color rendition and high levels of illumination.

A more recent technique of lighting high-rise signs utilizes Metalarc lamps mounted on or close to the ground. A narrow beam fixture is used to project the light up to the sign. Maintenance becomes much less expensive when compared to the internally lighted plastic signs normally used for this application.

Buildings that may be inconspicuous in the daytime take on an attention-attracting appearance at night when floodlighted with Metalarc lighting equipment.

### **Sports Arena and Stadium Lighting**

The high efficacy and superior color rendition of Metalarc lamps are dramatically illustrated every time these lamps are used in sports arenas and stadiums. Because color telecasting of football games, baseball series, hockey matches and other sporting events requires exceptionally high light output, many sports arenas and stadiums

are lighted with Metalarc lamps to provide the necessary higher footcandles and excellent color.

The 1500-watt Metalarc lamp is specifically designed for sports lighting applications. Two of the important features of this lamp are its high lumen output and good maintenance. The arc tube is designed to withstand the high currents present while maintaining good color rendition and high light output throughout rated life. The 1500-watt Metalarc lamp operates at a correlated color temperature which is compatible with color television broadcasting equipment. It is, therefore, highly suited to all sports arena and stadium lighting applications where maximum lighting levels at minimum cost are of prime importance.

### **Commercial Lighting**

For commercial interiors, such as banks, department stores, furniture stores, appliance dealers and supermarkets, the Metalarc/C and the 3K Metalarc lamps have been accepted by merchants as ideal light sources. Used in suspended or recessed lighting equipment, these lamps create a bright, cheerful store atmosphere that is pleasing to merchants and customers. Many supermarkets are benefiting from an average of 140-200 footcandles or more throughout the store. This is considerably above the national average of less than 100 footcandles in supermarkets. Especially beneficial also is the high level of vertical footcandles from Metalarc/C and 3K Metalarc lighting equipment, which provides adequate illumination not only at the top shelf but at the middle and bottom shelves as well. Colors of merchandise and packaging are especially vivid.

Applications of compact Metalarc lamps are continuing to grow in number every day. The future for these compact and highly efficient light sources with excellent color-rendering characteristics is limited only by the imagination of the designers of lighting installations and equipment. Compact Metalarc lamps now bring the challenge of creating new and exciting lighting concepts to lighting engineers and architects.

### **Open Versus Closed Fixtures**

Among the unique features of Metalarc Pro-Tech lamps is the fact that they eliminate the need for enclosed fixtures. This not only reduces the initial cost of fixtures, but also saves on maintenance time and costs since there are no lenses to keep clean. These Metalarc lamps also improve lighting efficiency. It is estimated that open floodlighting fixtures are four to eight percent more efficient than enclosed types. Certain high optical control fixtures such as those used in street lighting would also operate more efficiently with open fixtures. Other applications include indoor and outdoor sports facilities, parking lots, and shopping malls. Like all Metalarc lamps, Metalarc Pro-Tech lamps provide excellent color rendition and provide an ideal light source for retail, commercial and industrial applications where color considerations are important.

### **TROUBLESHOOTING**

Refer to the OSRAM SYLVANIA Trouble-Shooting Guide for High Intensity Discharge Lamps.

WARNING: This lamp can cause serious skin burn and eye inflammation from shortwave Ultraviolet radiation if the outer envelope of the lamp is broken or punctured. Do not use where people will remain for more than a few minutes unless adequate shielding or other safety precautions are used. Lamps that will automatically extinguish when the outer envelope is broken or punctured are commercially available.

---

## For Orders and General Information

OSRAM SYLVANIA National Customer Support Center, 18725 N. Union Street, Westfield, IN 46074

### **Industrial & Commercial**

Phone: 1-800-255-5042  
Fax: 1-800-255-5043

### **National Accounts**

Phone: 1-800-562-4671  
Fax: 1-800-562-4674

### **Special Markets**

Phone: 1-800-762-7191  
Fax: 1-800-762-7192

In Canada: OSRAM SYLVANIA LTD. Headquarters, 2001 Drew Road, Mississauga, ON L5S 1S4

### **Industrial & Commercial**

Phone: 1-800-2263-2852  
Fax: 1-800-667-6772

### **Special Markets**

Phone: 1-800-265-2852  
Fax: 1-800-667-6772

Visit our website: [www.sylvania.com](http://www.sylvania.com)

